

OIL & GAS

REMOTE SOLAR POWER SYSTEMS



Location: Louisiana Bayou
System Size: 6.25 kW



Location: West Texas
System Size: 40 W

From Cathodic Protection (CP) and valve actuation to flow monitoring, Kyocera has provided reliable and cost effective solutions to the Oil & Gas Industry for more than 30 years. Kyocera designed CP systems ensure maximum up-time by avoiding costly repairs due to the natural corrosion process of metals used in harsh environments.

THE NEW VALUE FRONTIER



SOLAR POWER

OIL & GAS REMOTE SYSTEM SOLUTION



Location: Oil Fields of West Texas
System Size: 4.3 kW

Kyocera's Oil & Gas Remote Solar Power Systems are well suited to operating automation equipment used by the Oil and Gas Industry. This equipment includes high-efficiency gas-flow computers, remote telemetry units (RTU's), supervisory control and data acquisition equipment (SCADA). The equipment's low power requirements and typically remote locations often make a PV system the most cost-effective power source.

Kyocera custom systems have been designed and manufactured to OEM or end-user specifications. The modular design of systems provides ultimate flexibility and allows you to construct a solar system to meet the exact needs of the SCADA and telemetry application.

OIL & GAS APPLICATIONS

- Cathodic Protection
- Telemetry
- RTU/SCADA
- Flow Monitoring
- Drilling Meters
- Natural Gas Automation
- Gas Flow Measurement
- Data Recording
- Control Valves
- Process Control Equipment
- Seismic Monitoring
- Air Quality Monitors



Location: Central Iowa
System Size: 40 W

PRODUCT LINE

KYOCERA'S 88 SERIES

REMOTE DATA ACQUISITION

REMOTE MONITORING & TELECOMMUNICATIONS SYSTEMS

Kyocera has designed self-contained, solar powered communication systems specifically for the petroleum industry's remote data acquisition needs in both land-based and offshore operations. Each power system provides steady, clean power to a variety of telemetry systems including custody transfer stations and natural gas automation sites.

CATHODIC PROTECTION



Location: Louisiana Bayou
System Size: 7.7kW

Kyocera's Cathodic Protection (CP) systems include solar modules, mounting structures, CP controller (with integrated solar charge regulation), storage batteries, system enclosure, installation/wiring kit and instruction manual.

Kyocera CP systems are specialized by providing DC current to metal pipelines, storage tanks, bridges, or other exposed equipment to cancel the effects of natural chemical corrosions. Operating directly from storage batteries common to photovoltaic systems, the Kyocera CP system is equipped with a low voltage shut-down feature to prevent battery damage and are suitable for use in systems of either positive or negative ground.

Kyocera CP systems provide a complete solar power supply solution for preventing corrosion of any metallic structure needing protection. KYOCERA SOLAR's high efficiency CP systems are designed specifically for remote unattended applications, where reliability is key.

Remote Power Solutions

CATHODIC PROTECTION (CP) SOLAR POWERED SYSTEMS

FEATURES

- Solid State CP Controller
- Adjustable Voltage/Current Outputs
- System Metering
- Automatic Low Voltage Shutdown
- Surge Suppression
- NEMA 3R Enclosures
- Vandal Resistant Designs (optional)
- Hot Dipped Galvanized Structures (optional)
- NEMA 4X Enclosures (optional)
- Installation Services (optional)

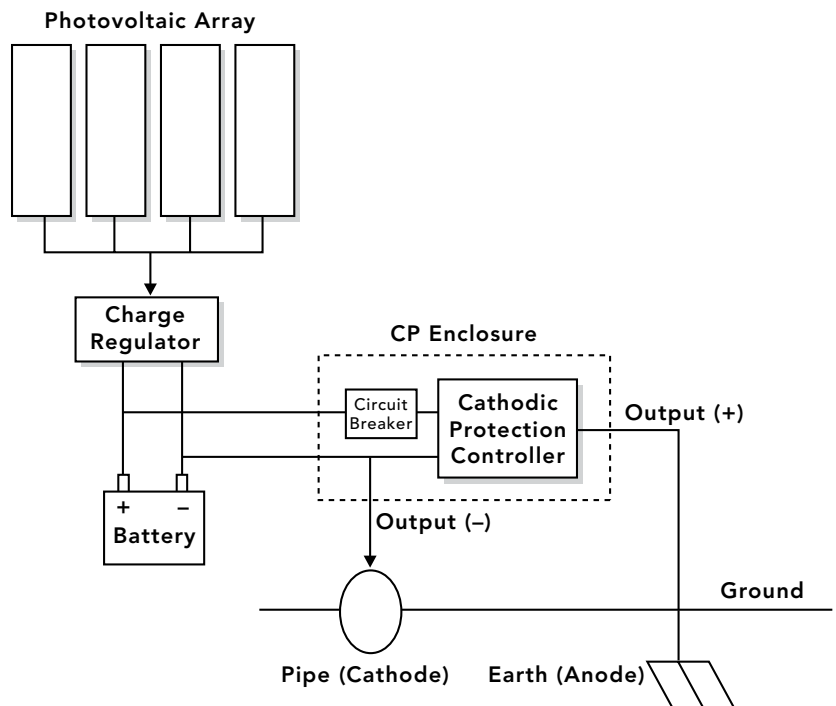



Location: Louisiana Bayou
System Size: 3.9 kW

FEATURES

- 25 Year Kyocera Solar Module Warranty
- Class I/DIV II Certified Solar Modules
- Complete System Packages
- Simple to Install and Easy to Maintain
- Thorough System Documentation
- Engineering Design Assistance
- Ground or Pole Mount Designs

KYOCERA CAPABILITIES

Kyocera offers comprehensive dealer support packages including customized engineering, proactive service and sales support, extensive training, and a variety of field services.

Kyocera solar systems are ideal for the Oil and Gas industry because they deliver clean, reliable, renewable power to such applications as Cathodic Protection (CP) systems and Remote Data Acquisition for both land-based and off-shore pipelines.



Location: Oman
System Size: 1.9 kW



THE NEW VALUE FRONTIER



KYOCERA Solar, Inc.
800-223-9580 toll-free
800-523-2329 fax
www.kyocerasolar.com